

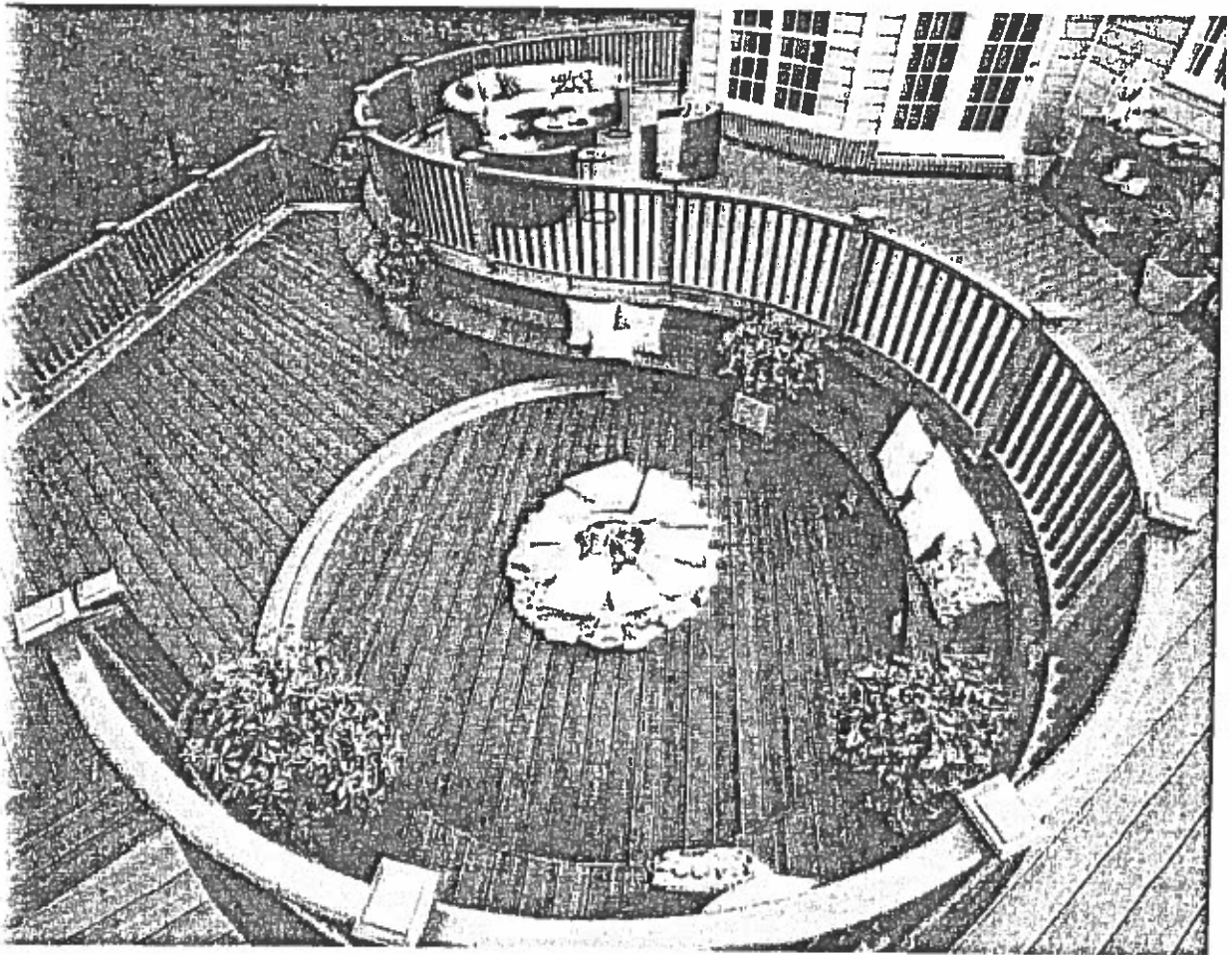

**TOWNSHIP OF MONTVILLE
BUILDING DEPARTMENT
193 CHANGEBRIDGE ROAD
MONTVILLE NJ 07045
973-331-3318**

DECKS



DECK REQUIREMENTS

- 1. If your project is subject to a Home Owners Association (HOA) review, a copy of the HOA approval MUST accompany your application.**
- 2. Please submit 2 copies of scaled drawings and manufacturer installation specs. (if using wood or composite materials) All drawings completed by the homeowner must be signed by the homeowner. If you are not the owner of the home, you will need to submit drawings by a licensed NJ registered architect or engineer.**
- 3. The drawings submitted shall indicate the following:**
 - a. Location of deck in relation to house**
 - b. Specify type of wood and/or composite being used**
 - c. A detailed cross section and plan view shall indicate footings, columns, girders, joints, ledger, flashing, decking, railing, handrails, stairways, lateral bracing, and connectors.**
 - d. Indicate height from grade to top of deck**
 - e. Show all dimensions on plans**

**USE THE 2018 IRC NJ SECTION 507
(ATTACHED) AS A GUIDE**

Updated 7-28-2020

R506.2.2 Base. A 4-inch-thick (102 mm) base course consisting of clean graded sand, gravel, crushed stone, crushed concrete or crushed blast-furnace slag passing a 2-inch (51 mm) sieve shall be placed on the prepared subgrade where the slab is below *grade*.

Exception: A base course is not required where the concrete slab is installed on well-drained or sand-gravel mixture soils classified as Group I according to the United Soil Classification System in accordance with Table R406.1.

R506.2.3 Vapor retarder. A 6-mil (0.006 inch; 152 mm) polyethylene or *approved* vapor retarder with joints lapped not less than 6 inches (152 mm) shall be placed between the concrete floor slab and the base course or the prepared subgrade where a base course does not exist.

Exception: The vapor retarder is not required for the following:

1. Garages, utility buildings and other unheated *accessory structures*.
2. For unheated storage rooms having an area of less than 70 square feet (6.5 m²) and carports.
3. Driveways, walks, patios and other flatwork not likely to be enclosed and heated at a later date.
4. Where *approved* by the *building official*, based on local site conditions.

R506.2.4 Reinforcement support. Where provided in slabs-on-ground, reinforcement shall be supported to remain in place from the center to upper one-third of the slab for the duration of the concrete placement.

SECTION R507 EXTERIOR DECKS

R507.1 Decks. Wood-framed decks shall be in accordance with this section. For decks using materials and conditions not prescribed in this section, refer to Section R301.

R507.2 Materials. Materials used for the construction of decks shall comply with this section.

R507.2.1 Wood materials. Wood materials shall be No. 2 grade or better lumber, preservative-treated in accordance with Section R317, or *approved*, naturally durable lumber, and termite protected where required in accordance with Section R318. Where design in accordance with Section R301 is provided, wood structural members shall be designed using the wet service factor defined in AWC NDS. Cuts, notches and drilled holes of preservative-treated wood members shall be treated in accordance with Section R317.1.1. All preservative-treated wood products in contact with the ground shall be labeled for such usage.

R507.2.1.1 Engineered wood products. Engineered wood products shall be in accordance with Section R502.

R507.2.2 Plastic composite deck boards, stair treads, guards, or handrails. Plastic composite exterior deck

boards, stair treads, guards and handrails shall comply with the requirements of ASTM D7032 and this section.

R507.2.2.1 Labeling. Plastic composite deck boards and stair treads, or their packaging, shall bear a label that indicates compliance with ASTM D7032 and includes the allowable load and maximum allowable span determined in accordance with ASTM D7032. Plastic or composite handrails and guards, or their packaging, shall bear a label that indicates compliance with ASTM D7032 and includes the maximum allowable span determined in accordance with ASTM D7032.

R507.2.2.2 Flame spread index. Plastic composite deck boards, stair treads, guards, and handrails shall exhibit a flame spread index not exceeding 200 when tested in accordance with ASTM E84 or UL 723 with the test specimen remaining in place during the test.

Exception: Plastic composites determined to be noncombustible.

R507.2.2.3 Decay resistance. Plastic composite deck boards, stair treads, guards and handrails containing wood, cellulose or other biodegradable materials shall be decay resistant in accordance with ASTM D7032.

R507.2.2.4 Termite resistance. Where required by Section 318, plastic composite deck boards, stair treads, guards and handrails containing wood, cellulose or other biodegradable materials shall be termite resistant in accordance with ASTM D7032.

R507.2.2.5 Installation of plastic composites. Plastic composite deck boards, stair treads, guards and handrails shall be installed in accordance with this code and the manufacturer's instructions.

R507.2.3 Fasteners and connectors. Metal fasteners and connectors used for all decks shall be in accordance with Section R317.3 and Table R507.2.3.

R507.2.4 Flashing. Flashing shall be corrosion-resistant metal of nominal thickness not less than 0.019 inch (0.48 mm) or *approved* nonmetallic material that is compatible with the substrate of the structure and the decking materials.

R507.2.5 Alternate materials. Alternative materials, including glass and metals, shall be permitted.

R507.3 Footings. Decks shall be supported on concrete footings or other approved structural systems designed to accommodate all loads in accordance with Section R301. Deck footings shall be sized to carry the imposed loads from the deck structure to the ground as shown in Figure R507.3. The footing depth shall be in accordance with Section R403.1.4.

Exception: Free-standing decks consisting of joists directly supported on grade over their entire length.

R507.3.1 Minimum size. The minimum size of concrete footings shall be in accordance with Table R507.3.1, based on the tributary area and allowable soil-bearing pressure in accordance with Table R401.4.1.

R507.3.2 Minimum depth. Deck footings shall extend below the frost line specified in Table R301.2(1) in accordance with Section R403.1.4.1.

Exceptions:

1. Free-standing decks that meet all of the following criteria:
 - 1.1. The joists bear directly on precast concrete pier blocks at grade without support by beams or posts.

- 1.2. The area of the deck does not exceed 200 square feet (18.9 m²).
 - 1.3. The walking surface is not more than 20 inches (616 mm) above grade at any point within 36 inches (914 mm) measured horizontally from the edge.
2. Free-standing decks need not be provided with footings that extend below the frost line.

TABLE R507.2.3 FASTENER AND CONNECTOR SPECIFICATIONS FOR DECKS^{a, b}

ITEM	MATERIAL	MINIMUM FINISH/COATING	ALTERNATE FINISH/COATING ^c
Nails and timber rivets	In accordance with ASTM F1667	Hot-dipped galvanized per ASTM A153	Stainless steel, silicon bronze or copper
Bolts ^c Lag screws ^d (including nuts and washers)	In accordance with ASTM A307 (bolts), ASTM A563 (nuts), ASTM F844 (washers)	Hot-dipped galvanized per ASTM A153, Class C (Class D for 1/4-inch diameter and less) or mechanically galvanized per ASTM B695, Class 55 or 410 stainless steel	Stainless steel, silicon bronze or copper
Metal connectors	Per manufacturer's specification	ASTM A653 type G185 zinc coated galvanized steel or post hot-dipped galvanized per ASTM A123 providing a minimum average coating weight of 2.0 oz./ft ² (total both sides)	Stainless steel

For SI: 1 inch = 25.4 mm, 1 foot = 304.8 mm.

- a. Equivalent materials, coatings and finishes shall be permitted.
- b. Fasteners and connectors exposed to salt water or located within 300 feet of a salt water shoreline shall be stainless steel.
- c. Holes for bolts shall be drilled a minimum 1/16 inch and a maximum 1/4 inch larger than the bolt.
- d. Lag screws 1/2 inch and larger shall be predrilled to avoid wood splitting per the National Design Specification (NDS) for Wood Construction.
- e. Stainless-steel-driven fasteners shall be in accordance with ASTM F1667.

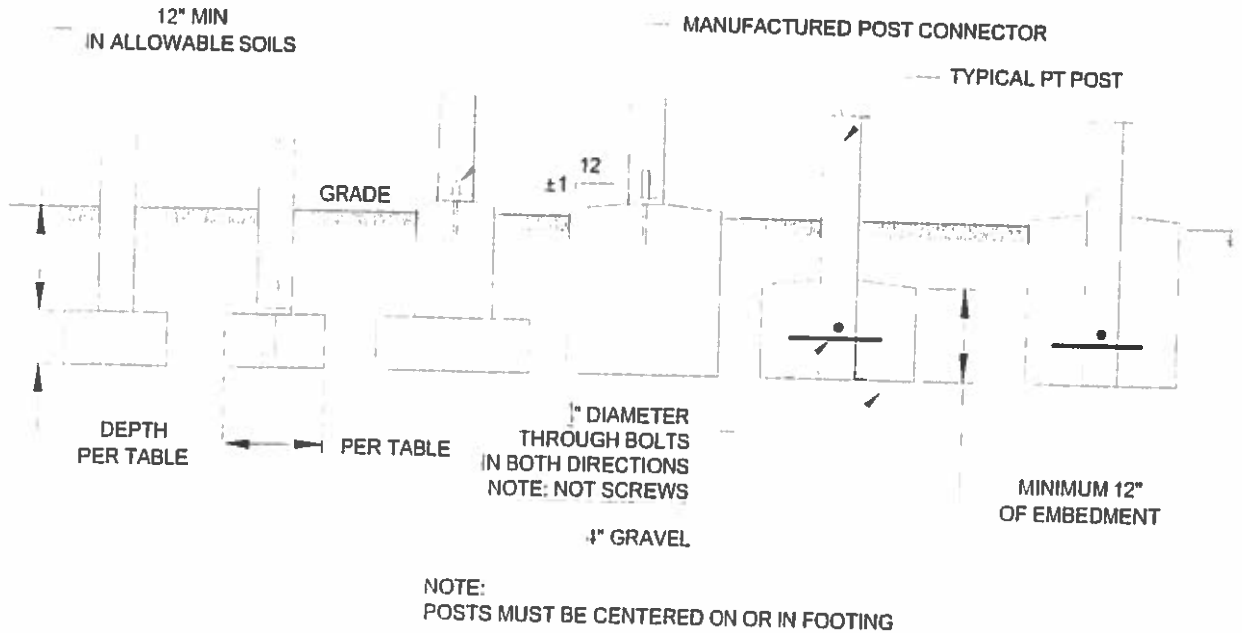

For SI: 1 inch = 25.4 mm.

FIGURE R507.3 DECK POSTS TO DECK FOOTING CONNECTION

TABLE R507.3.1
MINIMUM FOOTING SIZE FOR DECKS

LIVE OR GROUND SNOW LOAD ^a (psf)	TRIBUTARY AREA (sq. ft.)	LOAD BEARING VALUE OF SOILS ^{b, c, d} (psi)															
		1500 ^e				2000 ^e				2500 ^e				≥ 3000 ^e			
		Side of a square footing (inches)	Diameter of a round footing (inches)	Thickness (inches)	Side of a square footing (inches)	Diameter of a round footing (inches)	Thickness (inches)	Side of a square footing (inches)	Diameter of a round footing (inches)	Thickness (inches)	Side of a square footing (inches)	Diameter of a round footing (inches)	Thickness (inches)	Side of a square footing (inches)	Diameter of a round footing (inches)	Thickness (inches)	
40	20	12	14	6	12	14	6	12	14	6	12	14	6	12	14	6	
	40	14	16	6	12	14	6	12	14	6	12	14	6	12	14	6	
	60	17	19	6	15	17	6	13	15	6	13	15	6	12	14	6	
	80	20	22	7	17	19	6	15	17	6	15	17	6	14	16	6	
	100	22	25	8	19	21	6	17	19	6	17	19	6	15	17	6	
	120	24	27	9	21	23	7	19	21	7	19	21	7	17	19	6	
	140	26	29	10	22	25	8	20	23	8	20	23	7	18	21	6	
	160	28	31	11	24	27	9	21	24	9	21	24	8	20	22	7	
	20	12	14	6	12	14	6	12	14	6	12	14	6	12	14	6	
	40	15	17	6	13	15	6	12	14	6	12	14	6	12	14	6	
60	19	21	6	16	18	6	14	16	6	14	16	6	13	15	6		
80	21	24	8	19	21	6	17	19	6	17	19	6	15	17	6		
100	24	27	9	21	23	7	19	21	7	19	21	6	17	19	6		
120	26	30	10	23	26	8	20	23	8	20	23	7	19	21	6		
140	28	32	11	25	28	9	22	25	9	22	25	8	20	23	7		
160	30	34	12	26	30	10	24	27	10	24	27	9	21	24	8		
20	12	14	6	12	14	6	12	14	6	12	14	6	12	14	6		
40	16	19	6	14	16	6	13	15	6	13	15	6	12	14	6		
60	20	23	7	17	20	6	16	18	6	16	18	6	14	16	6		
80	23	26	9	20	23	7	18	20	7	18	20	6	16	18	6		
100	26	29	10	22	25	8	20	23	8	20	23	7	18	21	6		
120	28	32	11	25	28	9	22	25	9	22	25	8	20	23	7		
140	31	35	12	27	30	10	24	27	10	24	27	9	22	24	8		
160	33	37	13	28	32	11	25	29	11	25	29	10	23	26	9		
20	12	14	6	12	14	6	12	14	6	12	14	6	12	14	6		
40	18	20	6	15	17	6	11	13	6	11	13	6	12	14	6		
60	21	24	8	19	21	6	17	19	6	17	19	6	15	17	6		
80	25	28	9	21	24	8	19	22	8	19	22	7	18	20	6		
100	28	31	11	24	27	9	21	24	9	21	24	8	20	22	7		
120	30	34	12	26	30	10	24	27	10	24	27	9	21	24	8		
140	33	37	13	28	32	11	25	29	11	25	29	10	23	26	9		
160	35	40	15	30	34	12	27	31	12	27	31	11	25	28	9		

For SI: 1 inch = 25.4 mm, 1 square foot = 0.0929 m², 1 pound per square foot = 0.0479 kPa.
 a. Interpolation permitted, extrapolation not permitted.
 b. Based on highest load case: Dead + Live or Dead + Snow.
 c. Assumes minimum square footing to be 12 inches x 12 inches x 6 inches for 6 x 6 post.
 d. If the support is a brick or CMU pier, the footing shall have a minimum 2-inch projection on all sides.
 e. Area, in square feet, of deck surface supported by post and footings.

R507.4 Deck posts. For single-level wood-framed decks with beams sized in accordance with Table R507.5, deck post size shall be in accordance with Table R507.4.

**TABLE R507.4
DECK POST HEIGHT^a**

DECK POST SIZE	MAXIMUM HEIGHT ^{a,b} (feet-inches)
4 × 4	6-9 ^c
4 × 6	8
6 × 6	14
8 × 8	14

For SI: 1 inch = 25.4 mm, 1 foot = 304.8 mm,
1 pound per square foot = 0.0479 kPa.

- Measured to the underside of the beam.
- Based on 40 psf live load.
- The maximum permitted height is 8 feet for one-ply and two-ply beams. The maximum permitted height for three-ply beams on post cap is 6 feet 9 inches.

R507.4.1 Deck post to deck footing connection. Where posts bear on concrete footings in accordance with Section R403 and Figure R507.4.1, lateral restraint shall be provided by manufactured connectors or a minimum post embedment of 12 inches (305 mm) in surrounding soils or concrete piers. Other footing systems shall be permitted.

Exception: Where expansive, compressible, shifting or other questionable soils are present, surrounding soils shall not be relied on for lateral support.

R507.5 Deck Beams. Maximum allowable spans for wood deck beams, as shown in Figure R507.5, shall be in accordance with Table R507.5. Beam plies shall be fastened with two rows of 10d (3-inch × 0.128-inch) nails minimum at 16 inches (406 mm) on center along each edge. Beams shall be permitted to cantilever at each end up to one-fourth of the allowable beam span. Deck beams of other materials shall be permitted where designed in accordance with accepted engineering practices.

R507.5.1 Deck beam bearing. The ends of beams shall have not less than 1½ inches (38 mm) of bearing on wood or metal and not less than 3 inches (76 mm) of bearing on concrete or masonry for the entire width of the beam. Where multiple-span beams bear on intermediate posts, each ply must have full bearing on the post in accordance with Figures R507.5.1(1) and R507.5.1(2).

R507.5.2 Deck beam connection to supports. Deck beams shall be attached to supports in a manner capable of transferring vertical loads and resisting horizontal displacement. Deck beam connections to wood posts shall be in accordance with Figures R507.5.1(1) and R507.5.1(2). Manufactured post-to-beam connectors shall be sized for the post and beam sizes. Bolts shall have washers under the head and nut.

R507.6 Deck joists. Maximum allowable spans for wood deck joists, as shown in Figure R507.6, shall be in accordance with Table R507.6. The maximum joist spacing shall be limited by the decking materials in accordance with Table R507.7. The maximum joist cantilever shall be limited to one-fourth of the joist span or the maximum cantilever length specified in Table R507.6, whichever is less.

R507.6.1 Deck joist bearing. The ends of joists shall have not less than 1½ inches (38 mm) of bearing on wood or metal and not less than 3 inches (76 mm) of bearing on concrete or masonry over its entire width. Joists bearing on top of a multiple-ply beam or ledger shall be fastened in accordance with Table R602.3(1). Joists bearing on top of a single-ply beam or ledger shall be attached by a mechanical connector. Joist framing into the side of a beam or ledger board shall be supported by approved joist hangers.

R507.6.2 Deck joist lateral restraint. Joist ends and bearing locations shall be provided with lateral resistance to prevent rotation. Where lateral restraint is provided by joist hangers or blocking between joists, their depth shall equal not less than 60 percent of the joist depth. Where lateral restraint is provided by rim joists, they shall be secured to the end of each joist with not fewer than three 10d (3-inch by 0.128-inch) (76 mm by 3.3 mm) nails or three No. 10x 3-inch (76 mm) long wood screws.

R507.7 Decking. Maximum allowable spacing for joists supporting decking shall be in accordance with Table R507.7. Wood decking shall be attached to each supporting member with not less than two 8d threaded nails or two No. 8 wood screws. Other approved decking or fastener systems shall be installed in accordance with the manufacturer's installation requirements.

R507.8 Vertical and lateral supports. Where supported by attachment to an exterior wall, decks shall be positively anchored to the primary structure and designed for both vertical and lateral loads. Such attachment shall not be accomplished by the use of toenails or nails subject to withdrawal. For decks with cantilevered framing members, connection to exterior walls or other framing members shall be designed and constructed to resist uplift resulting from the full live load specified in Table R301.5 acting on the cantilevered portion of the deck. Where positive connection to the primary building structure cannot be verified during inspection, decks shall be self-supporting.

R507.9 Vertical and lateral supports at band joist. Vertical and lateral supports for decks shall comply with this section.

R507.9.1 Vertical supports. Vertical loads shall be transferred to band joists with ledgers in accordance with this section.

R507.9.1.1 Ledger details. Deck ledgers shall be a minimum 2-inch by 8-inch (51 mm by 203 mm) nominal, pressure-preservative-treated Southern pine, incised pressure-preservative-treated hem-fir, or approved, naturally durable, No. 2 grade or better lumber. Deck ledgers shall not support concentrated loads from beams or girders. Deck ledgers shall not be supported on stone or masonry veneer.

R507.9.1.2 Band joist details. Band joists supporting a ledger shall be a minimum 2-inch-nominal (51 mm), solid-sawn, spruce-pine-fir or better lumber or a minimum 1-inch by 9½-inch (25 mm × 241 mm) dimensional, Douglas fir or better, laminated veneer lumber. Band joists shall bear fully on the primary structure capable of supporting all required loads.

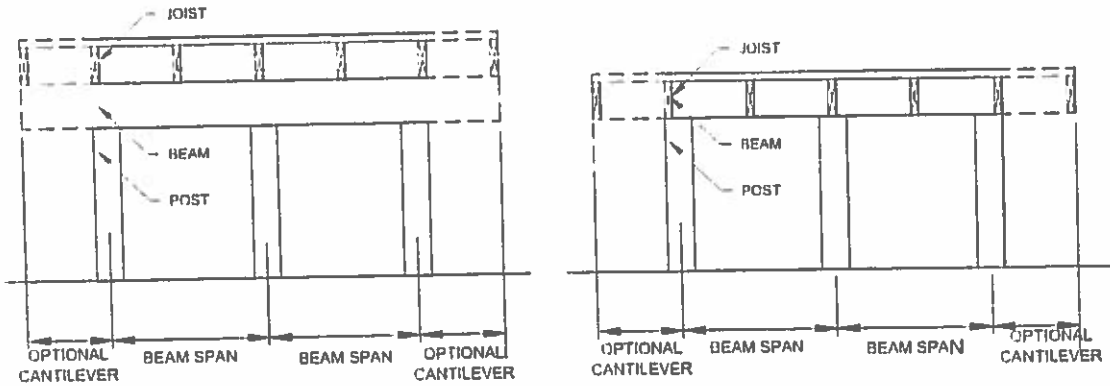

DROPPED BEAM

FLUSH BEAM

FIGURE R507.5
TYPICAL DECK JOIST SPANS

TABLE R507.5
DECK BEAM SPAN LENGTHS^{a, b, c, d} (feet - inches)

SPECIES ^e	SIZE ^d	DECK JOIST SPAN LESS THAN OR EQUAL TO: (feet)						
		6	8	10	12	14	16	18
Southern pine	1 - 2 x 6	4-11	4-0	3-7	3-3	3-0	2-10	2-8
	1 - 2 x 8	5-11	5-1	4-7	4-2	2-10	3-7	3-5
	1 - 2 x 10	7-0	6-0	5-5	4-11	4-7	4-3	4-0
	1 - 2 x 12	8-3	7-1	6-4	5-10	5-5	5-0	4-9
	2 - 2 x 6	6-11	5-11	5-4	4-10	4-6	4-3	4-0
	2 - 2 x 8	8-9	7-7	6-9	6-2	5-9	5-4	5-0
	2 - 2 x 10	10-4	9-0	8-0	7-4	6-9	6-4	6-0
	2 - 2 x 12	12-2	10-7	9-5	8-7	8-0	7-6	7-0
	3 - 2 x 6	8-2	7-5	6-8	6-1	5-8	5-3	5-0
	3 - 2 x 8	10-10	9-6	8-6	7-9	7-2	6-8	6-4
	3 - 2 x 10	13-0	11-3	10-0	9-2	8-6	7-11	7-6
3 - 2 x 12	15-3	13-3	11-10	10-9	10-0	9-4	8-10	
Douglas fir-larch ^f , hem-fir ^e , spruce-pine-fir ^e , redwood, western cedars, ponderosa pine ^f , red pine ^f	3 x 6 or 2 - 2 x 6	5-5	4-8	4-2	3-10	3-6	3-1	2-9
	3 x 8 or 2 - 2 x 8	6-10	5-11	5-4	4-10	4-6	4-1	3-8
	3 x 10 or 2 - 2 x 10	8-4	7-3	6-6	5-11	5-6	5-1	4-8
	3 x 12 or 2 - 2 x 12	9-8	8-5	7-6	6-10	6-4	5-11	5-7
	4 x 6	6-5	5-6	4-11	4-6	4-2	3-11	3-8
	4 x 8	8-5	7-3	6-6	5-11	5-6	5-2	4-10
	4 x 10	9-11	8-7	7-8	7-0	6-6	6-1	5-8
	4 x 12	11-5	9-11	8-10	8-1	7-6	7-0	6-7
	3 - 2 x 6	7-4	6-8	6-0	5-6	5-1	4-9	4-6
	3 - 2 x 8	9-8	8-6	7-7	6-11	6-5	6-0	5-8
	3 - 2 x 10	12-0	10-5	9-4	8-6	7-10	7-4	6-11
	3 - 2 x 12	13-11	12-1	10-9	9-10	9-1	8-6	8-1

For SE: 1 inch = 25.4 mm, 1 foot = 304.8 mm, 1 pound per square foot = 0.0479 kPa, 1 pound = 0.454 kg.

- a. Ground snow load, live load = 40 psf, dead load = 10 psf, L/Δ = 360 at main span, L/Δ = 180 at cantilever with a 220-pound point load applied at the end.
- b. Beams supporting deck joists from one side only.
- c. No. 2 grade, wet service factor.
- d. Beam depth shall be greater than or equal to depth of joists with a flush beam condition.
- e. Includes incising factor.
- f. Northern species. Incising factor not included.
- g. Beam cantilevers are limited to the adjacent beam's span divided by 4.

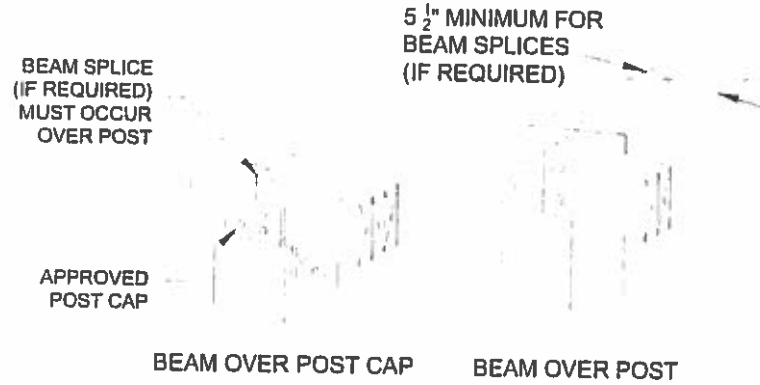

For SI: 1 inch = 25.4 mm.

FIGURE R507.5.1(1)
DECK BEAM TO DECK POST

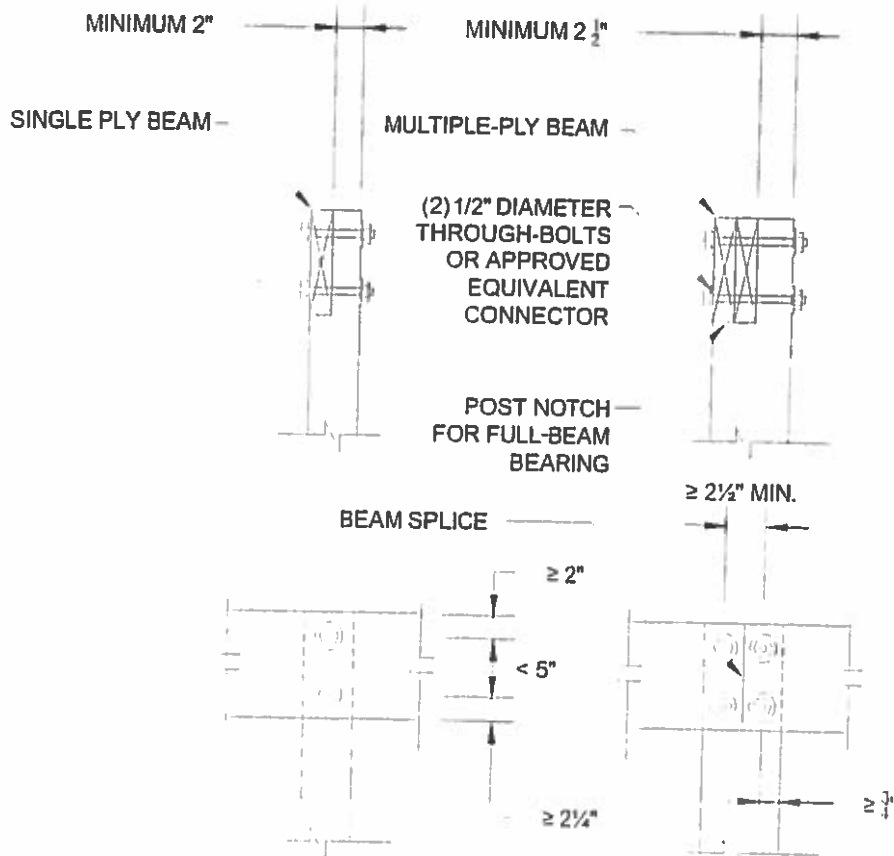

For SI: 1 inch = 25.4 mm.

FIGURE R507.5.1(2)
NOTCHED POST-TO-BEAM CONNECTION

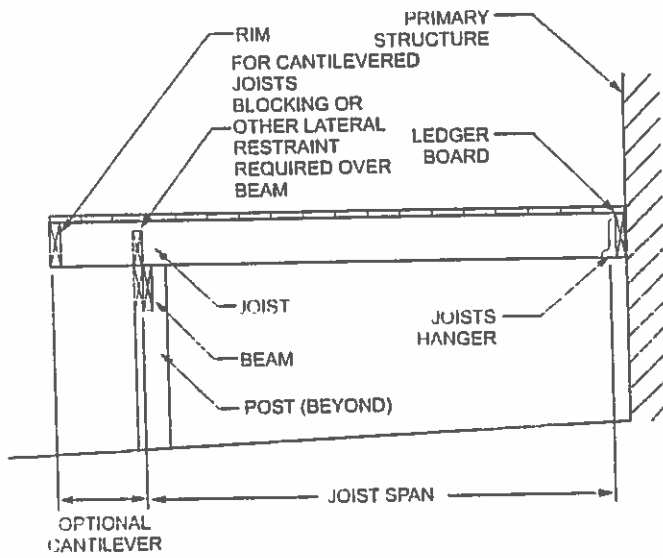

CANTILEVERED JOISTS WITH DROPPED BEAM

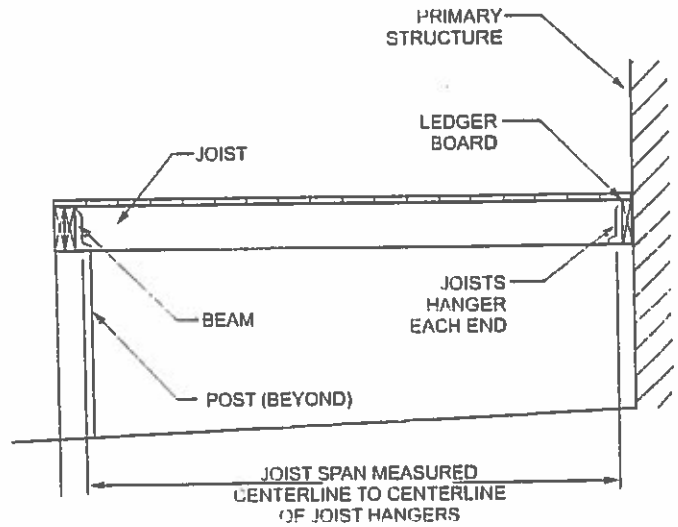

JOISTS WITH FLUSH BEAM

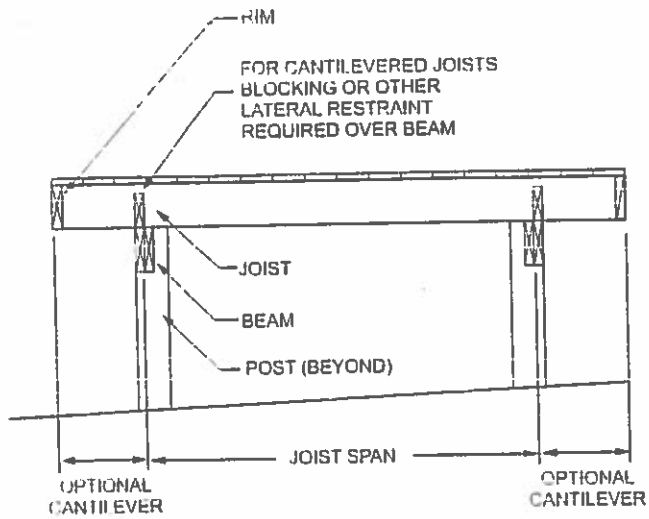

JOISTS ON FREE-STANDING DECK WITH DROPPED BEAM

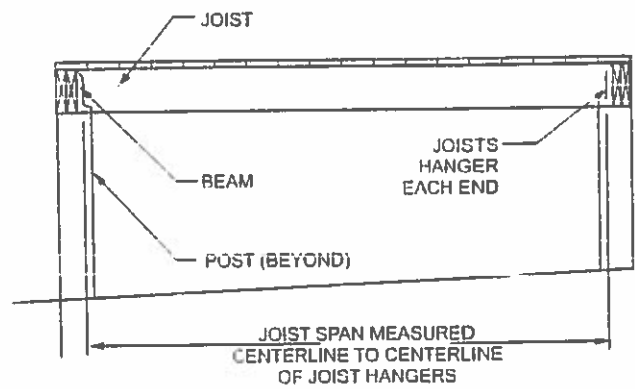

JOISTS ON FREE-STANDING DECK WITH FLUSH BEAM

FIGURE R507.6
TYPICAL DECK JOIST SPANS

TABLE R507.6
DECK JOIST SPANS FOR COMMON LUMBER SPECIES (ft. - in.)

SPECIES ^a	SIZE	ALLOWABLE JOIST SPAN ^b			MAXIMUM CANTILEVER ^{c,f}		
		SPACING OF DECK JOISTS (Inches)			SPACING OF DECK JOISTS WITH CANTILEVERS ^e (Inches)		
		12	18	24	12	18	24
Southern pine	2 × 6	9-11	9-0	7-7	1-3	1-4	1-6
	2 × 8	13-1	11-10	9-8	2-1	2-3	2-5
	2 × 10	16-2	14-0	11-5	3-4	3-6	2-10
	2 × 12	18-0	16-6	13-6	4-6	4-2	3-4
Douglas fir-larch ^d , hem-fir ^d , spruce-pine-fir ^d	2 × 6	9-6	8-8	7-2	1-2	1-3	1-5
	2 × 8	12-6	11-1	9-1	1-11	2-1	2-3
	2 × 10	15-8	13-7	11-1	3-1	3-5	2-9
	2 × 12	18-0	15-9	12-10	4-6	3-11	3-3
Redwood, western cedars, ponderosa pine ^e , red pine ^e	2 × 6	8-10	8-0	7-0	1-0	1-1	1-2
	2 × 8	11-8	10-7	8-8	1-8	1-10	2-0
	2 × 10	14-11	13-0	10-7	2-8	2-10	2-8
	2 × 12	17-5	15-1	12-4	3-10	3-9	3-1

For SI: 1 inch = 25.4 mm, 1 foot = 304.8 mm, 1 pound per square foot = 0.0479 kPa, 1 pound = 0.454 kg.

- No. 2 grade with wet service factor.
- Ground snow load, live load = 40 psf, dead load = 10 psf, L/Δ = 360.
- Ground snow load, live load = 40 psf, dead load = 10 psf, L/Δ = 360 at main span, L/Δ = 180 at cantilever with a 220-pound point load applied to end.
- Includes incising factor.
- Northern species with no incising factor.
- Cantilevered spans not exceeding the nominal depth of the joist are permitted.

TABLE R507.7
MAXIMUM JOIST SPACING FOR DECKING

DECKING MATERIAL TYPE AND NOMINAL SIZE	MAXIMUM ON-CENTER JOIST SPACING	
	Decking perpendicular to joist	Decking diagonal to joist ^a
1 1/4-inch-thick wood	16 inches	12 inches
2-inch-thick wood	24 inches	16 inches
Plastic composite	In accordance with Section R507.2	In accordance with Section R507.2

For SI: 1 inch = 25.4 mm, 1 foot = 304.8 mm, 1 degree = 0.01745 rad.

- Maximum angle of 45 degrees from perpendicular for wood deck boards.

R507.9.1.3 Ledger to band joist details. Fasteners used in deck ledger connections in accordance with Table R507.9.1.3(1) shall be hot-dipped galvanized or stainless steel and shall be installed in accordance with Table R507.9.1.3(2) and Figures R507.9.1.3(1) and R507.9.1.3(2).

R507.9.1.4 Alternate ledger details. Alternate framing configurations supporting a ledger constructed to meet the load requirements of Section R301.5 shall be permitted.

R507.9.2 Lateral connection. Lateral loads shall be transferred to the ground or to a structure capable of transmit-

ting them to the ground. Where the lateral load connection is provided in accordance with Figure R507.9.2(1), hold-down tension devices shall be installed in not less than two locations per deck, within 24 inches (610 mm) of each end of the deck. Each device shall have an allowable stress design capacity of not less than 1,500 pounds (6672 N). Where the lateral load connections are provided in accordance with Figure R507.9.2(2), the hold-down tension devices shall be installed in not less than four locations per deck, and each device shall have an allowable stress design capacity of not less than 750 pounds (3336 N).

TABLE R507.9.1.3(1)
DECK LEDGER CONNECTION TO BAND JOIST^{a, b}
 (Deck live load = 40 psf, deck dead load = 10 psf, snow load ≤ 40 psf)

CONNECTION DETAILS	JOIST SPAN						
	6' and less	6'1" to 8'	8'1" to 10'	10'1" to 12'	12'1" to 14'	14'1" to 16'	16'1" to 18'
	On-center spacing of fasteners						
1/2-inch diameter lag screw with 1/2-inch maximum sheathing ^{c, d}	30	23	18	15	13	11	10
1/2-inch diameter bolt with 1/2-inch maximum sheathing ^d	36	36	34	29	24	21	19
1/2-inch diameter bolt with 1-inch maximum sheathing ^e	36	36	29	24	21	18	16

For SI: 1 inch = 25.4 mm, 1 foot = 304.8 mm, 1 pound per square foot = 0.0479 kPa.

- a. Ledgers shall be flashed in accordance with Section R703.4 to prevent water from contacting the house band joist.
- b. Snow load shall not be assumed to act concurrently with live load.
- c. The tip of the lag screw shall fully extend beyond the inside face of the band joist.
- d. Sheathing shall be wood structural panel or solid sawn lumber.
- e. Sheathing shall be permitted to be wood structural panel, gypsum board, fiberboard, lumber or foam sheathing. Up to 1/2-inch thickness of stacked washers shall be permitted to substitute for up to 1/2 inch of allowable sheathing thickness where combined with wood structural panel or lumber sheathing.

TABLE R507.9.1.3(2)
PLACEMENT OF LAG SCREWS AND BOLTS IN DECK LEDGERS AND BAND JOISTS

	MINIMUM END AND EDGE DISTANCES AND SPACING BETWEEN ROWS			
	TOP EDGE	BOTTOM EDGE	ENDS	ROW SPACING
Ledger ^a	2 inches ^d	1/2 inch	2 inches ^b	1 1/4 inches ^b
Band Joist ^c	1/2 inch	2 inches	2 inches ^b	1 1/4 inches ^b

For SI: 1 inch = 25.4 mm.

- a. Lag screws or bolts shall be staggered from the top to the bottom along the horizontal run of the deck ledger in accordance with Figure R507.9.1.3(1).
- b. Maximum 5 inches.
- c. For engineered rim joists, the manufacturer's recommendations shall govern.
- d. The minimum distance from bottom row of lag screws or bolts to the top edge of the ledger shall be in accordance with Figure R507.9.1.3(1).

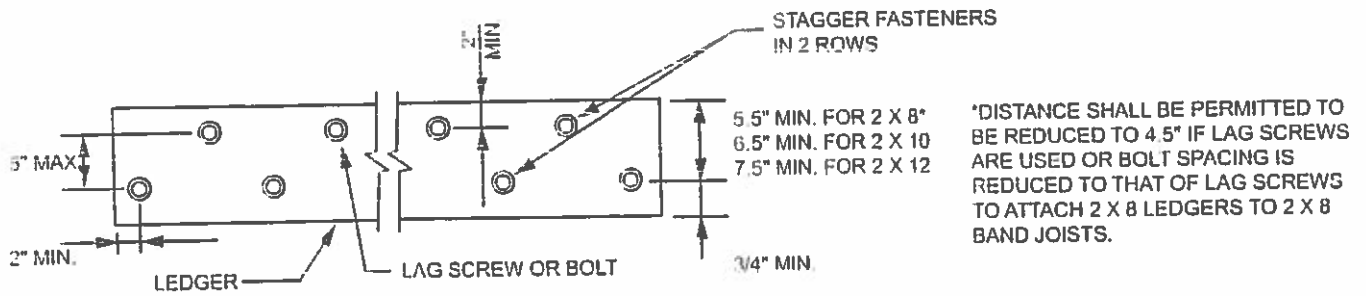

For SI: 1 inch = 25.4 mm.

FIGURE R507.9.1.3(1)
PLACEMENT OF LAG SCREWS AND BOLTS IN LEDGERS

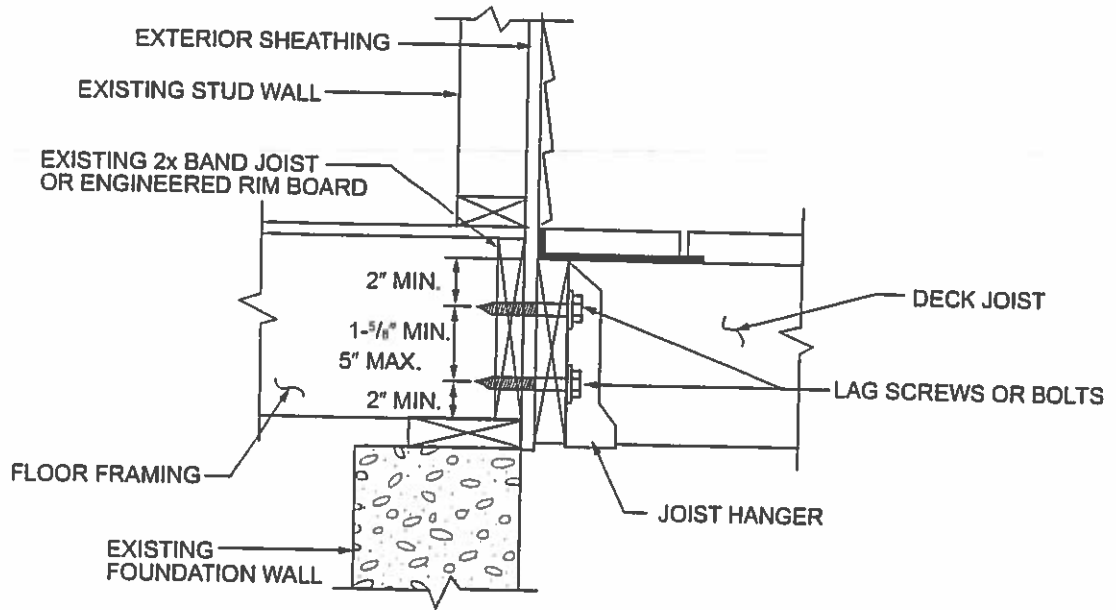

For SI: 1 inch = 25.4 mm.

FIGURE R507.9.1.3(2)
PLACEMENT OF LAG SCREWS AND BOLTS IN BAND JOISTS

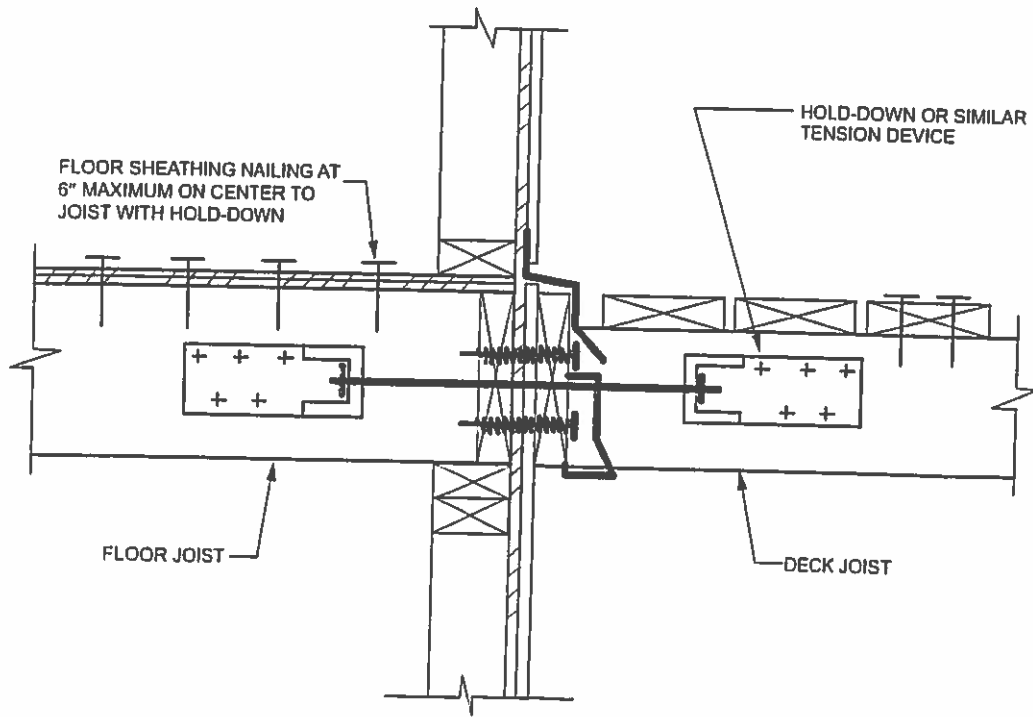

For SI: 1 inch = 25.4 mm.

FIGURE R507.9.2(1)
DECK ATTACHMENT FOR LATERAL LOADS

NOTE
THIS DETAIL IS APPLICABLE
WHERE FLOOR JOISTS ARE
PARALLEL TO DECK JOISTS.

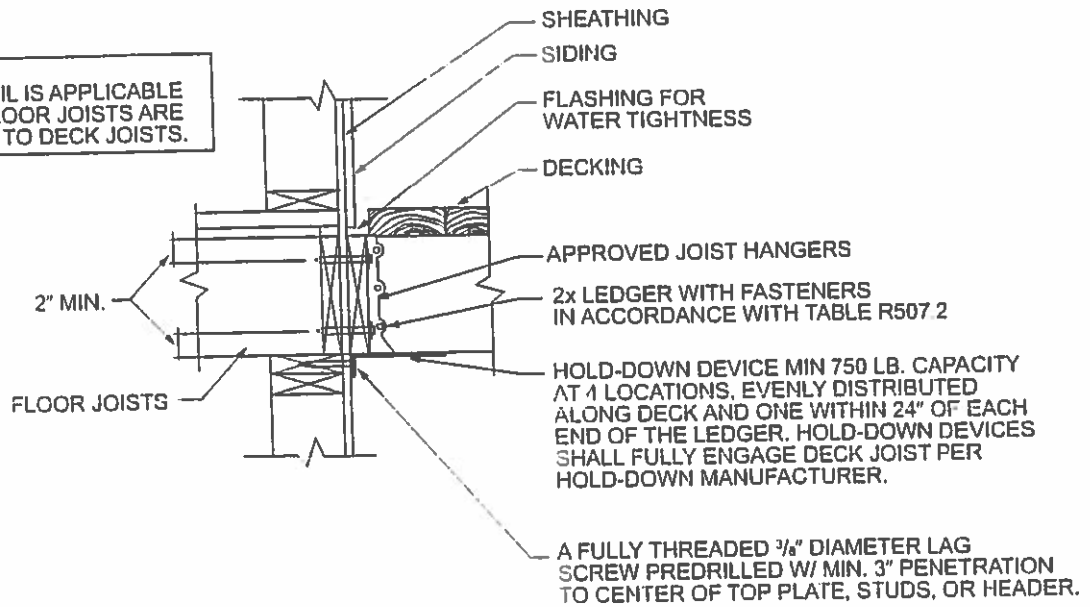

For SI: 1 inch = 25.4 mm, 1 foot = 304.8 mm.

FIGURE R507.9.2(2)
DECK ATTACHMENT FOR LATERAL LOADS